

# CENTURY<sup>®</sup>

COMMERCIAL TRUCK COVERS



**THE RIGHT FIT**  
Style. Security. Selection.

# CUSTOMIZABLE MODULAR TOOL BOXES

## MODULAR TOOL BOX OPTIONS

# CENTURY®

## COMMERCIAL TRUCK COVERS

### DCU™-MT3 MODULAR TOOL BOX ADVANTAGES

- Movable, sturdy, modular tool boxes allow endless configurations for your application
- 20 gauge galvalneal steel with a white powder-coat finish – 20% heavier than our standard tool box



*Shown with these options: MT3-J, side door windows and accessory kits*



**Option MT3-A** Tool Box



**Option MT3-B** Tool Box with Full Shelf Kit



**Option MT3-C** Tool Box with Full Shelf Kit and One Bottom Divider



**Option MT3-D** Tool Box with One Full Shelf Kit, One Upper and One Bottom Divider



**Option MT3-J** Tool Box with One Half Shelf Kit and One Center Divider



**MT3-J** Tool Box Shown with Optional Dividers

- Rear Radius Picture Window for Half Door
- Side Door Windows



### DCU™- MT3 ADVANTAGES

- Wider, taller side access doors – up to 29% more entry space
- Reinforced super cage infrastructure – 17% stronger than our standard
- CENTURY's first all-aluminum truck cover with modular tool box capability

ALUMINUM DCU-MT3



• Larger Opening Side Door • Rear Radius Picture Window for Half Door

**DCU- MT3 CAP HEIGHTS**

<b>Compact</b>	20"	23"	26"	30"	36"	-
<b>Full Size</b>	-	23"	26"	30"	36"	40"
<b>Super Duty</b>	-	-	26"	30"	36"	40"

**Wedge Options COMING SOON!**

Check with your Century Dealer for availability  
(Heights Low to High)

<b>Compact / Full Size</b>	23" - 26"
<b>Compact / Full Size</b>	23" - 30"
<b>Compact / Full Size</b>	23" - 36"
<b>Super Duty</b>	26" - 30"
<b>Super Duty</b>	26" - 36"



• 26" Full Size (Option)

**DCU- MT3 SIDE DOOR DIMENSIONS**

Model	Extra Short Bed	Short Bed	Long Bed
<b>Ford F-150 2015+</b>	59" L	69" L	85" L
<b>Ford Super Duty 2017+</b>	N/A	69" L	85" L
<b>Silverado / Sierra 2014+</b>	59" L	69" L	85" L
<b>Silverado / Sierra 2007 - 2013</b>	59" L	69" L	85" L
<b>Toyota Tundra</b>	56" L	69" L	85" L
<b>Ram 2009 - 2018</b>	59" L	66" L	85" L

Cap Height	Door Opening
23"	16-3/8" H
26"	18-15/16" H
30", 36", 40"	22-7/8" H



• Full Length Side Door • Double Full Doors



**Bolt Lock with Stainless Steel Drop T-handle**



**.035 Exterior Smooth Skin Aluminum Roof Metal**

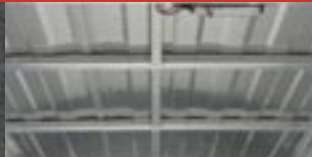

**Improved, TIG Welded Super Cage Roof Integrated Construction**  
Extra Short Bed – 3 Ribs  
Short Bed – 4 Ribs  
Long Bed – 5 Ribs



**Window Security Screen (Option)**



**Rolling Rods for Smooth Action, Secure Closing**



**Heavy Duty Aluminum Base Rails for Mounting with Interior Clamps**



**Bolt Plate Reinforcement for Aftermarket Rack System (Option)**



**LED THIRD BRAKE LIGHT WITH BACK-UP CAMERA**  
is required on DCU-MT3 and DCU full door units for 2015+ newer trucks. Optional on all other trucks. Fits OEM tailgate wiring.

# DCU COMMERCIAL CAPS

## DCU CAP HEIGHTS

<b>Compact</b>	20"	23"	26"	30"	36"	-
<b>Full Size</b>	-	23"	26"	30"	36"	40"
<b>Super Duty</b>	-	-	26"	30"	36"	40"

## Wedge Options

(Heights Low to High)

<b>Compact / Full Size</b>	23" - 26"
<b>Compact / Full Size</b>	23" - 30"
<b>Compact / Full Size</b>	23" - 36"
<b>Super Duty</b>	26" - 30"
<b>Super Duty</b>	26" - 36"

## DOOR DIMENSIONS

Model	Extra Short Bed	Short Bed	Long Bed
<b>Ford F-150 2015+</b>	59" L	66" L	82" L
<b>Ford Super Duty 2017+</b>	N/A	66" L	82" L
<b>Silverado / Sierra 2014+</b>	59" L	66" L	82" L
<b>Silverado / Sierra 2007 - 2013</b>	59" L	66" L	82" L
<b>Toyota Tundra</b>	56" L	66" L	82" L
<b>Ram 2009 - 2019</b>	59" L	66" L	82" L

Cap Height	Door Opening
<b>23"</b>	15-3/8" H
<b>26"</b>	15-3/8" H
<b>30", 36", 40"</b>	20-7/8" H



Shown with Rear Radius Picture Window for Half Door and DECKED Organizer (Option)



## DCU WEDGE

- 26" Full Size Wedge Option • Full Length Side Door
- Radius Rear Half Door with Picture Window



## DCU

- 23" Height Cap • Full Length Side Door • Single Full Rear Door • Stainless Steel T-Handle Bolt Locks



## DCU

- 26" Height Cap • Full Length Side Door
- Double Doors with Long Radius Windows

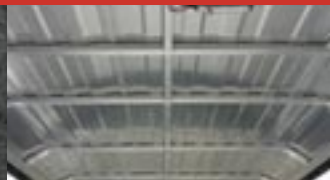

TIG Welded Super Cage Roof Integrated Construction  
Extra Short Bed - 3 Bows  
Short Bed - 3 Bows  
Long Bed - 4 Bows



Side Door (Standard)



Side Door Skin Metal Skin Interior (Option)



Side Tool Box with Full Shelf and Divider (Option)

# ULTRA CF



*This sleek, good looking CENTURY cab-high cap provides a secure workshop while maintaining the automotive appeal of your truck.*

*Shown with Optional ErgoRack™ Single Clamping/Single Rotation Ladder Rack*



**ULTRA CF**



**ULTRA CF**

# BUILT WORKSITE TOUGH

**HIGH C CF** *This CENTURY mid-rise commercial cap is reinforced for commercial roof racks, offers optional fiberglass side doors, tool box options and more.*



**HIGH C CF**  
*This CENTURY mid-rise commercial cap is reinforced for commercial roof racks, offers optional fiberglass side doors, tool box options, and more*



**HIGH C CF** *Optional Painted Side Access Door*

FIBERGLASS

# DCU-MT3/DCU Order Form

Truck Year \_\_\_\_\_ Truck Brand \_\_\_\_\_

Truck Model \_\_\_\_\_

### Cab Style

- Regular Cab  Quad Cab – 4 Door  
 Extended Cab  Double Cab

### Box Style

- Long Box  Short Box  
 Extra Short  Flareside/Sportside/Stepside

Truck VIN \_\_\_\_\_

Truck Color Code \_\_\_\_\_

Choose One:  DCU-MT3  DCU

## 1. AVAILABLE COLORS: .035

- YZ White  Polar White  Dove Grey  Black

### CUSTOM PAINT OPTION:

- Base Coat/Clear Coat Automotive Paint  
 Tri-Coat Paint (Additional Cost)

### TRIM CHOICES:

- Black – Standard  White – Optional

## 2. FRONT OPTIONS:

Consider needed visibility, accessibility and security.

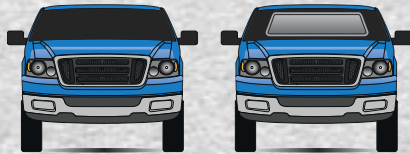

- Solid Front Wall (Standard)

- Front Radius Picture Window



- Front Radius Sliding Window

- DCU Front Rectangular Picture Window

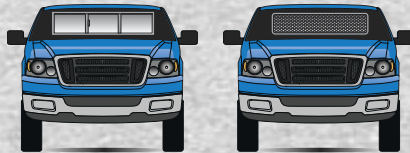

- DCU Front Rectangular Sliding Window

- DCU Front Security Screen

## 3. HEIGHT OPTIONS:

Important factors to consider when selecting the right height for your needs: headroom, accessibility and storage capacity.

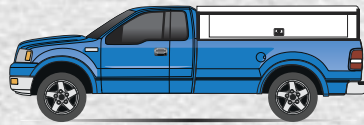

- 23" High – Compact (Standard)  
 23" High – Full Size (Standard)

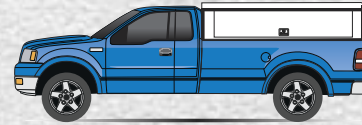

- 26" High Rise – Compact  
 26" High Rise – Full Size  
 26" High – Super Duty (Standard)

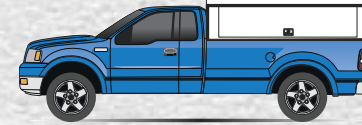

- 30" High Rise – Compact  
 30" High Rise – Full Size  
 30" Super Duty

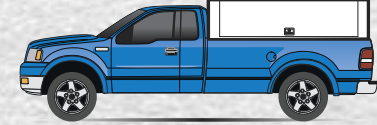

- 36" High Rise – Compact  
 36" High Rise – Full Size  
 36" Super Duty

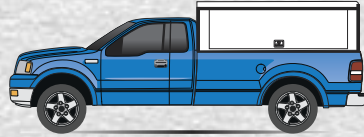

- 40" High Rise – Full Size  
 40" Super Duty

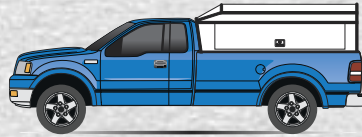

- 23" - 26" Wedge – Compact  
 23" - 26" Wedge – Full Size

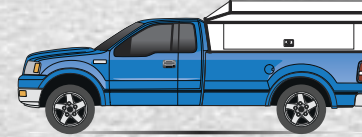

- 23" - 30" Wedge – Compact  
 23" - 30" Wedge – Full Size  
 26" - 30" Super Duty

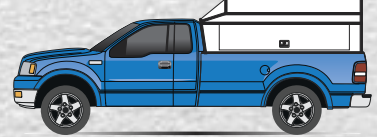

- 23" - 36" Wedge – Compact  
 23" - 36" Wedge – Full Size  
 26" - 36" Super Duty

DCU-MT3 WEDGE OPTIONS COMING SOON! Check with your Century Dealer for availability.

## 4. REAR OPTIONS:

Consider security, visibility and access requirements when selecting rear options.

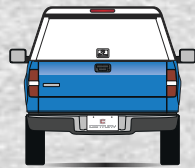

- Solid Half Door (Standard)

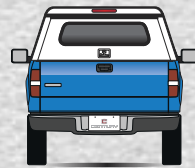

- Half Door with Radius Picture Window

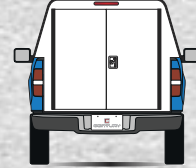

- Double Full Doors

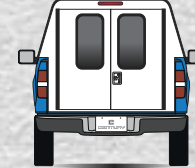

- Double Full Doors with Two Long Radius Windows

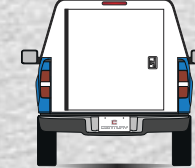

- Single Full Door

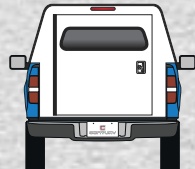

- Single Full Door with Radius Picture Window

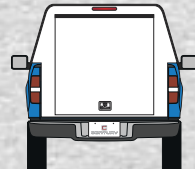

- Hatchback Full Door

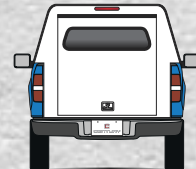

- Hatchback Door with Radius Picture Window

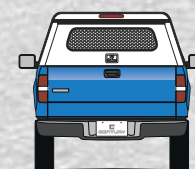

- Rear Security Screen

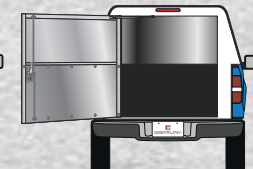

- Metal Skin Interior

### Metal Skin Options

- Metal Skin Interior of Rear 1/2 door  
 Metal Skin Full Interior Height of Rear Double Doors  
 Metal Skin Full Interior Height of Single Full Door  
 Metal Skin Full Interior Height Hatchback Door

## 5. SIDE OPTIONS:

Choose from a variety of side options to customize your DCU-MT3 or DCU.



- Side Lift Door with Stainless Steel Drop T-Handle and Bolt Lock (Standard)  
 Drivers Side  Passengers Side

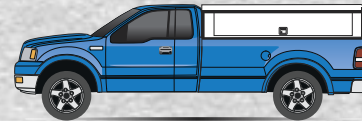

- Side Lift Door with Stainless Steel Drop T-Handle with Bolt Lock for 8' Truck Beds (Optional) 69" DCU-MT3 / 66" DCU  
 Drivers Side  Passengers Side

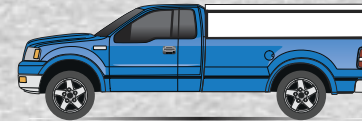

- Solid Sides (Delete Side Door)  
 Drivers Side  Passengers Side  
 Solid Side Metal Skin Interior  
 Drivers Side  Passengers Side

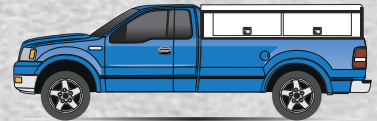

- 41" Double Side Doors DCU-MT3 (Long beds only)  
 40" Double Side Doors DCU (Long beds only)  
 Drivers Side  Passengers Side

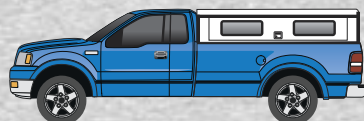

- Side Lift Door with Two Side Radius Windows  
 Drivers Side  Passengers Side

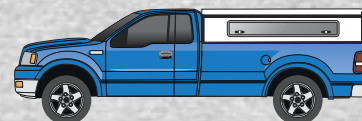

- Radius Side Window  
 Drivers Side  Passengers Side

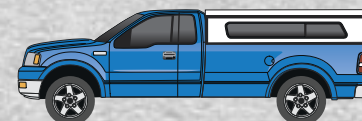

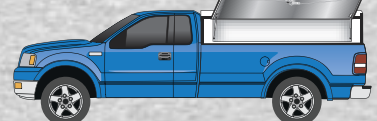

- Radius Side Sliding Window  
 Drivers Side  Passengers Side





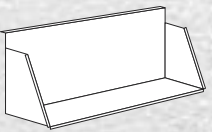
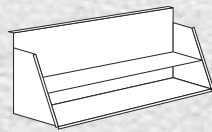
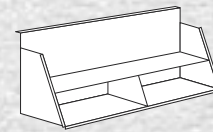
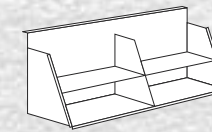
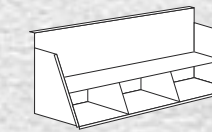
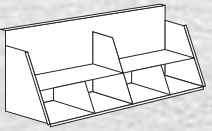
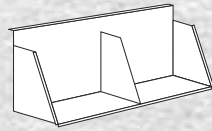
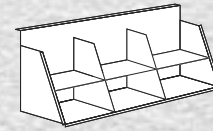
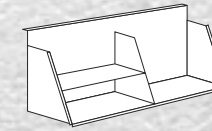
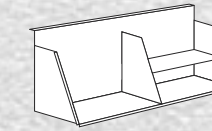
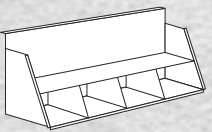
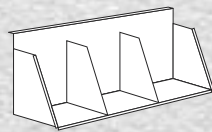
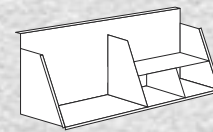
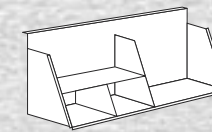
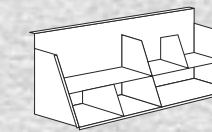
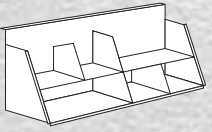
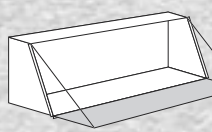
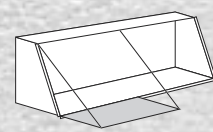
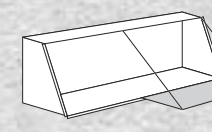



- Side Door Metal Skin Interior  
 Drivers Side  Passengers Side

**6. DCU / DCU-MT3 TOOL BOX SHELF & DIVIDER OPTIONS:** Please specify driver or passenger side for tool box configurations.

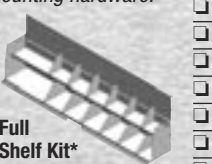
 <b>Option MT3-A / Option A</b> Tool Box	 <b>Option MT3-B / Option B</b> Tool Box with Full Shelf Kit	 <b>Option MT3-C / Option C</b> Tool Box with Full Shelf Kit & 1 Bottom Divider	 <b>Option MT3-D / Option D</b> Tool Box with 1 Full Shelf, 1 Upper & 1 Bottom Divider	 <b>Option E / DCU</b> Tool Box with Full Shelf & 2 Vertical Dividers
 <b>Option F / DCU Only</b> Tool Box with Full Shelf & 4 Vertical Dividers	 <b>Option G / DCU Only</b> Tool Box with 1 Large Vertical Divider	 <b>Option H / DCU Only</b> Tool Box with Full Shelf & 4 Vertical Dividers	 <b>Option I / DCU Only</b> Tool Box with Large Vertical Divider & Left Side Half Shelf	 <b>Option MT3-J / Option J</b> Tool Box with 1 Half Shelf Kit, Center Divider
 <b>Option K / DCU Only</b> Tool Box with 1 Full Shelf & 3 Vertical Dividers	 <b>Option L / DCU Only</b> Tool Box with 2 Vertical Dividers	 <b>Option M / DCU Only</b> Tool Box with Large Vertical Divider, Right Side Half Shelf & Vertical Divider	 <b>Option N / DCU Only</b> Tool Box with Large Vertical Shelf, Left Side Half Shelf & Vertical Divider	 <b>Option O / DCU Only</b> Full Shelf Center Divider, with 1 Vertical Forward Top & 1 Vertical Rear Bottom
 <b>Option P / DCU Only</b> Full Shelf Center Divider, with 1 Vertical Rear Top & 1 Forward Bottom	 <b>Option Q / DCU Only</b> Fold-Down Work Shelf (Requires Tool Box Option)	 <b>Option R / DCU Only</b> Half Shelf Rear Shown as Passenger Side (Requires Tool Box Option)	 <b>Option S / DCU Only</b> Half Shelf Front Shown as Passenger Side (Requires Tool Box Option)	

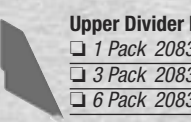
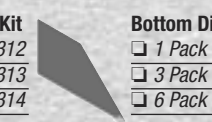
**DCU-MT3 MODULAR TOOL BOX ACCESSORY KITS:**

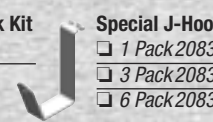
\*Shown with shelf kits and dividers, (Sold separately). Includes mounting hardware.

 <b>Tool Box Kit</b>	 <b>Full Shelf Kit*</b>	 <b>Half Shelf Kit*</b>
 <b>Upper Divider Kit</b> □ 1 Pack 208312 □ 3 Pack 208313 □ 6 Pack 208314	 <b>Bottom Divider Kit</b> □ 1 Pack 208315 □ 3 Pack 208316 □ 6 Pack 208317	 <b>Wide Hook Kit</b> □ 1 Pack 208319
 <b>Triple Hook Kit</b> □ 208320	 <b>Special J-Hook</b> □ 1 Pack 208309 □ 3 Pack 208310 □ 6 Pack 208311	 <b>Basket Kit</b> □ 208318





**7. INTERIOR LIGHTING AND POWER OPTIONS:**

Select additional lights to improve visibility at night.

 <b>12V Three Outlet Power Block</b>	 <b>12V Fuse Box (Standard)</b>	 <b>DCU Third Brake Light (Standard)</b>	 <b>LED Third Brake Light with Back-up Camera is required on DCU-MT3 &amp; DCU full door units for 2015+ newer trucks. Optional on all other trucks. Fits OEM Tailgate Wiring.</b>
---	---	--	--

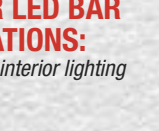
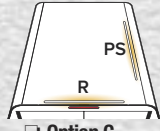
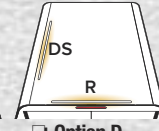
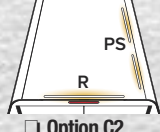
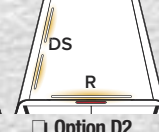
**8. INTERIOR LED BAR LIGHT LOCATIONS:**

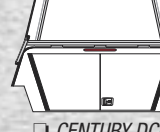
Choose from ten interior lighting configurations.

 <b>Option A</b>	 <b>Option B</b>
 <b>Option C</b>	 <b>Option D</b>
 <b>Option E</b>	 <b>Option F</b>
 <b>Option C2</b> 8' Models Only	 <b>Option D2</b> 8' Models Only
 <b>Option E2</b> 8' Models Only	 <b>Option F2</b> 8' Models Only

**9. DCU RACK OPTIONS:** Select the rack that fits your application.

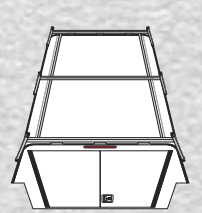
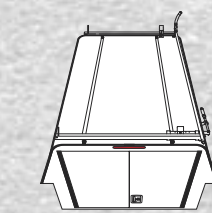
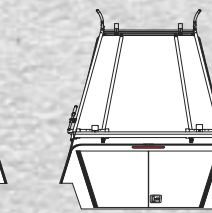
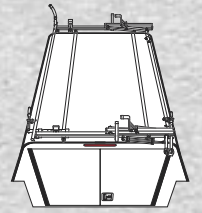
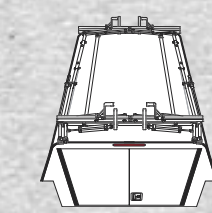
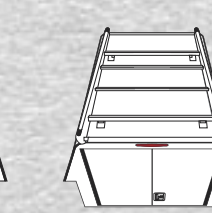
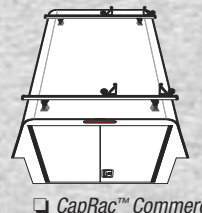
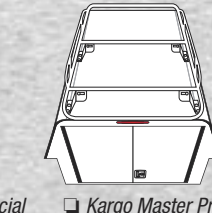
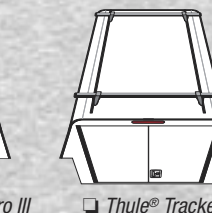
 <b>CENTURY DCU Six Position Mount Welded Aluminum Ladder Rack</b>	 <b>ErgoRack™ Single Clamping Ladder Rack</b>	 <b>ErgoRack™ Double Clamping Ladder Rack</b>
 <b>ErgoRack™ Single Clamping/Single Rotation Ladder Rack</b>	 <b>ErgoRack™ Dual Rotation Ladder Rack</b>	 <b>AluRack™ Ladder Rack</b>
 <b>CapRac™ Commercial Rack System by TracRac with Load Stops</b>	 <b>Kargo Master Pro III Cap Mount Rack</b>	 <b>Thule® Tracker II Rack with Locks</b>

**TRUCK BED ACCESSORIES:**

- BEDSLIDE® Classic
- BEDSLIDE® Contractor
- BEDSLIDE® Heavy Duty
- DECKED Organizer
- BEDRUG Bedliner

**10. INTERIOR OPTIONS:**

- Interior Rack □ 5-1/2" x 16" □ 8-1/2" x 16"
- Interior Headliner □ Black □ Grey
- Roof Only □ Complete Unit Side Doors Excluded
- Metal Skin Interior □ Roof Only □ Solid Front Wall Only
- Roof & Solid Front Wall Only

DCU-MT3 / DCU ORDER FORM

# ULTRA CF & HIGH C CF ORDER FORM

Truck Year \_\_\_\_\_ Truck Brand \_\_\_\_\_

Truck Model \_\_\_\_\_

Cab Style  Regular Cab  Extended Cab  
 Quad Cab – 4 Door  Double Cab

Box Style  Long Box  Short Box  
 Extra Short  Flareside/  
 Sportside/Stepside

Truck VIN \_\_\_\_\_

Truck Color Code \_\_\_\_\_

## 1. AUTOMOTIVE PAINT OPTION:

- Base Coat/Clear Coat Automotive Paint
- Tri-Coat Paint (Additional Cost)

## 2. FRONT OPTIONS:

Consider needed visibility, accessibility and security.

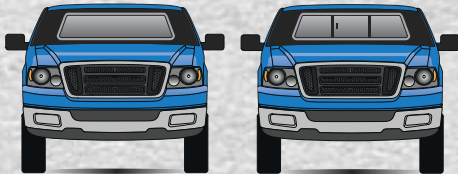

- Roped-in Fixed Front Window (Standard)
- Radius Framed Front Picture Window
- Radius Framed Removable Front Picture Window – (N/A with Tool Boxes)
- Front Radius Sliding Window
- Radius Framed Removable Front Sliding Window – (N/A with Tool Boxes)

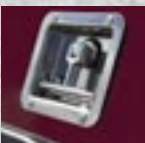

Stainless Steel Drop T-handle



Optional Painted Access Door with Tool Box

## 3. ULTRA CF REAR OPTIONS:

Consider security, visibility and access requirements.



- Ultra CF Recessed Dark Tint Rear Door with Double T-Handles (Standard)

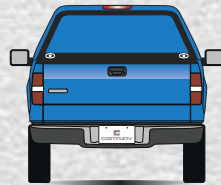

- Ultra CF Solid Rear Door with Color Matched Aluminum Insert & Double T-Handles

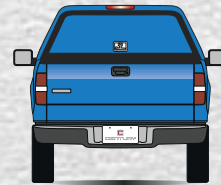

- Ultra CF Solid Rear Door with Color Matched Fiberglass Insert & Stainless Steel Drop T-Handle

## 4. ULTRA CF SIDE OPTIONS:

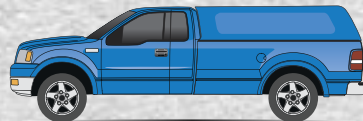

- Solid Sides No Windows (Standard) (Sides will show recess)*
- Drivers Side  Passengers Side

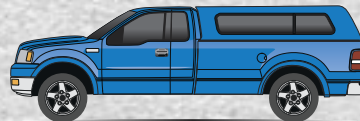

- 70/30 Side Slider Window with Screen*
- Drivers Side  Passengers Side
- Screen Protectors for 70/30 Side Slider Window with Screen*
- Drivers Side  Passengers Side

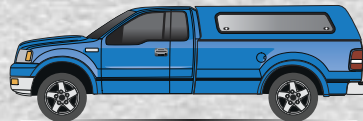

- Radius Side Window (Window N/A with tool boxes)*
- Drivers Side  Passengers Side

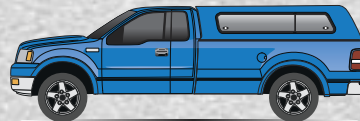

- Radius Side Window Slider (Window Slider N/A with tool boxes)*
- Drivers Side  Passengers Side

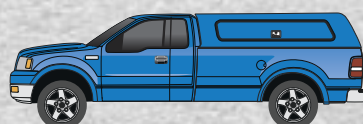

- Radius Side Painted Access Door with Stainless Steel Drop T-Handle*
- Drivers Side  Passengers Side

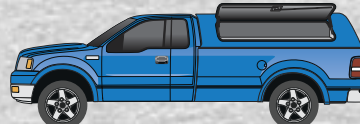

- Radius Side Painted Access Door with Tool Box*
- Drivers Side  Passengers Side

## 3. HIGH C CF REAR OPTIONS:

Consider security, visibility and access requirements.



- High C CF Recessed Dark Tint Rear Door with Double T-Handles (Standard)

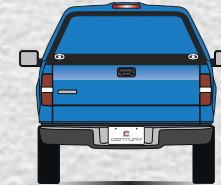

- High C CF Solid Rear Door with Color Matched Aluminum Insert & Double T-Handles

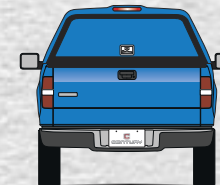

- High C CF Solid Rear Door with Color Matched Fiberglass Insert & Stainless Steel Drop T-Handle

## 4. HIGH C CF SIDE OPTIONS:



- Solid Sides No Windows (Standard) (Sides will show recess)*
- Drivers Side  Passengers Side



- 70/30 Side Slider Window with Screen*
- Drivers Side  Passengers Side
- Screen Protectors for 70/30 Side Slider Window with Screen*
- Drivers Side  Passengers Side

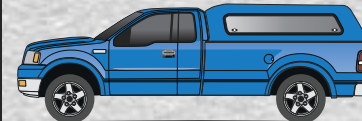

- Radius Side Window (Window N/A with tool boxes)*
- Drivers Side  Passengers Side



- Radius Side Window Slider (Window Slider N/A with tool boxes)*
- Drivers Side  Passengers Side

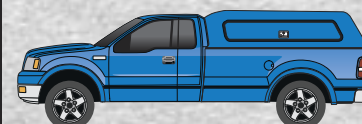

- Radius Side Painted Access Door with Stainless Steel Drop T-Handle*
- Drivers Side  Passengers Side

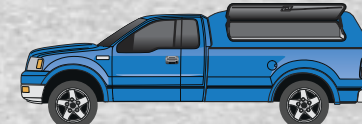

- Radius Side Painted Access Door with Tool Box*
- Drivers Side  Passengers Side



**5. TOOL BOX SHELF AND DIVIDER OPTIONS:** Please specify driver or passenger side for tool box configurations.

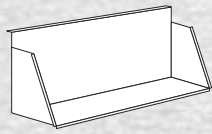

**Option A**  
Tool Box

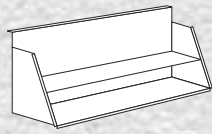

**Option B**  
Tool Box with Full Shelf

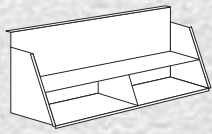

**Option C**  
Tool Box with Full Shelf  
& 1 Vertical Divider

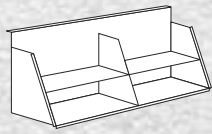

**Option D**  
Tool Box with Full Shelf  
& 2 Vertical Dividers

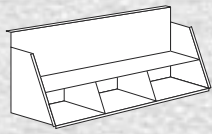

**Option E**  
Tool Box with Full Shelf  
& 2 Vertical Dividers

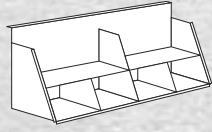

**Option F**  
Tool Box with Full Shelf  
& 4 Vertical Dividers

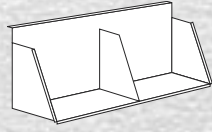

**Option G**  
Tool Box with 1 Large  
Vertical Divider

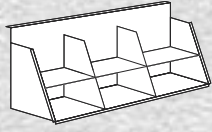

**Option H**  
Tool Box with Full Shelf  
& 4 Vertical Dividers

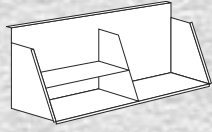

**Option I**  
Tool Box with Large Vertical  
Divider & Left Side Half Shelf

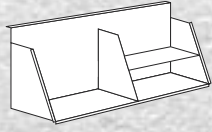

**Option J**  
Tool Box with Large Vertical  
Divider & Right Side Half Shelf

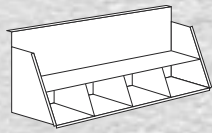

**Option K**  
Tool Box with 1 Full Shelf  
& 3 Vertical Dividers

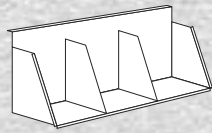

**Option L**  
Tool Box with 2 Vertical  
Dividers

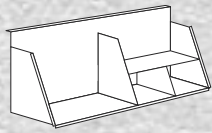

**Option M**  
Tool Box with Large Vertical  
Divider, Right Side Half Shelf  
& Vertical Divider

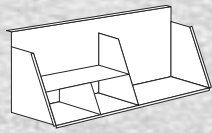

**Option N**  
Tool Box with Large Vertical  
Divider, Left Side Half Shelf  
& Vertical Divider

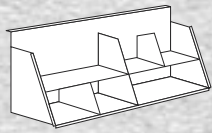

**Option O**  
Full Shelf Center Divider, with  
1 Vertical Forward Top & 1  
Vertical Rear Bottom

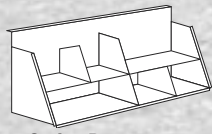

**Option P**  
Full Shelf Center Divider, with  
1 Vertical Rear Top &  
1 Forward Bottom

**6. INTERIOR LIGHTING AND POWER OPTIONS:**

Select additional lights to improve visibility at night.



**12V Fuse Box**  
(Standard)

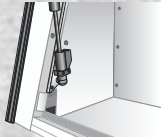

**12V LED  
Automatic Gas  
Prop Switch**



**7. INTERIOR LED LIGHT BAR LOCATIONS:**



**Option A**  
(Standard)



**Option B**



**Option C**



**Option D**



**Option E**



**Option F**

**8. FIBERGLASS COMMERCIAL RACK OPTIONS:**

Select the rack that fits your application.

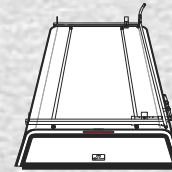

**ErgoRack™ Single  
Clamping Ladder Rack**

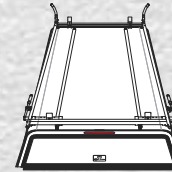

**ErgoRack™ Double  
Clamping Ladder Rack**

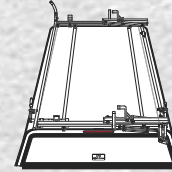

**ErgoRack™ Single  
Clamping/Single  
Rotation Ladder Rack**

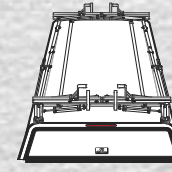

**ErgoRack™ Dual  
Rotation Ladder Rack**

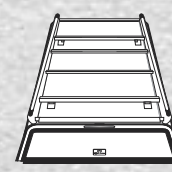

**AluRack™  
Ladder Rack**

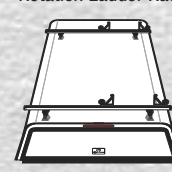

**CapRac™ Commercial  
Rack System by TracRac  
with Load Stops**

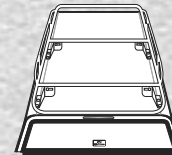

**Kargo Master Pro III  
Cap Mount Rack**



**Thule® AeroBlade  
Rack with Locks**  
 **Thule Tracks Only**

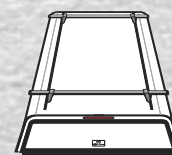

**Thule® Tracker II  
Rack with Locks**  
 **Thule Tracks Only**

Prime Design™ Roof Racks fit both High C CF and Ultra CF.

**9. INTERIOR OPTIONS:**

**Interior Headliner** (Standard)

**Black**  **Grey**

**Cargo Hooks**

**4 Drivers Side**  **4 Passengers Side**  **8 Drivers Side and Passengers Side**

**TRUCK BED ACCESSORIES:**

**BEDSLIDE GO**

**BEDSLIDE Classic**

**BEDSLIDE Sport**

**BEDSLIDE Contractor**

**BEDSLIDE Heavy Duty**

**DECKED Organizer**

**BEDRUG Bedliner**

**STORAGE SOLUTIONS:**



Optional  
Three Shelf  
Storage Unit



Optional Tool Box with  
Storage Bin



Rear Radius Picture Window for 1/2 Door (Option)



Window Security Screen (Option)



Radius Front Picture Window (Option)



Three Shelf Storage Unit (Option)



Side Tool Box 40" LED Lighting (Option)



BEDRUG (Option)

CENTURY® COMMERCIAL CAP FEATURES	DCU™-MT3	DCU	ULTRA CF	HIGH CCF
Improved, TIG Welded "Super Cage" Integrated Roof Construction	●			
TIG Welded "Super Cage" Integrated Roof Construction		●		
Modular Tool Box for Added Versatility	■			
Larger Opening Side Doors with Gas Props	●			
Standard Length Side Doors with Gas Props		●		
.035 Exterior Smooth Skin Aluminum	●	●		
Stainless Steel Drop-T Handles and BOLT Locks with "One Key Technology"	●	●		
12V Fuse Box	●	●	●	●
Exterior Mounted LED Third Brake Light	●	●		
Heavy Duty Aluminum Base Rails	●	●		
Black Trim	●	●		
White Trim	■	■		
Commercial Cap Structural Reinforcement	●	●	●	●
5-Year Color and Structure Limited Warranty	●	●	●	●
<b>CHOICE OF AVAILABLE COLORS</b>				
.035 YZ White (Ford)	■	■		
.035 Polar White	■	■		
.035 Black	■	■		
.035 Dove Grey	■	■		
<b>FACTORY INSTALLED AUTOMOTIVE PAINT</b>				
Axalta Base Coat/Clear Coat	■	■	●	●
ChromaPremiere® Automotive Paint				
Tri-Coat Automotive Paint (Additional Cost)			■	■
<b>FRONT</b>				
Solid Front Wall (No window)	●	●		
Fixed Front Window			●	●
Rectangular Front Picture Window (Stationary or sliding)	■	■		
Radius Front Picture Window (Stationary or sliding)	■	■	■	■
Radius Framed Front Picture Window (Stationary or sliding)			■	■
Radius Framed Removable Front Picture Window (Stationary or sliding) (N/A with tool boxes)			■	■
Window Security Screen (Available for rectangular picture windows only)	■	■		

CENTURY® COMMERCIAL CAP FEATURES	DCU™-MT3	DCU	ULTRA CF	HIGH CCF
<b>REAR</b>				
Solid Half Rear Lift Door with Gas Props, Contoured Door Skirt, Stainless Drop T-Handle and BOLT Lock	●	●		
Recessed Dark Tint Rear Door with Double T-Handles			●	●
Rear Radius Picture Window for 1/2 Door	■	■		
Double Full Doors Flush Mount with Stainless Drop T-Handle and BOLT Lock	■	■		
Two Long Radius Windows for Full Doors	■	■		
Single Full Door Flush Mount with Stainless Drop T-Handle and BOLT Lock – Left Side Hinge	■	■		
Rear Radius Picture Window for Single Full Door	■	■		
Hatchback Full Door with Stainless Drop T-Handle and BOLT Lock	■	■		
Rear Radius Picture Window for Hatchback Full Door	■	■		
Window Security Screen	■	■		
Metal Skin Full Interior Height (Hatchback, half, double and single doors)	■	■		
Solid Rear Door with Color Matched Aluminum Insert			■	■
Solid Rear Door with Color Matched Fiberglass Insert, Drop T-Handle			■	■
Exterior Mounted LED Third Brake Light with Back-up Camera (Required on 2015+ and newer trucks)	■	■		
<b>SIDE DOOR</b>				
Double Full Length Solid Side Doors with Stainless Steel Drop T-Handle and BOLT Lock	●	●	■	■
Side Door Windows	■	■		
Side Door Metal Skin Interior	■	■		
Solid Sides (No doors or windows)	■	■	●	●
Double Side Doors with Stainless Steel Drop T-Handle and BOLT Lock (8' Units only) ( DCU-MT3 41" / DCU 40")	■	■		
Side Door with Stainless Steel Drop T-Handle and Bolt Lock (8' Units only) ( DCU-MT3 69" / DCU 66")	■	■		
CENTURY Fiberglass Construction			●	●
Fiberglass Base Rails			●	●

● = Standard Equipment    ■ = Optional



Bolt Plate Reinforcement for Aftermarket Rack System (Option)



DECKED is available for full-size short, full-size extra short and mid-size truck beds. (Option)



Prime Design™ Locking Ladder Rack (Option)



BEDSLIDE® an Easy Access Truck Bed Sliding Drawer (Option)

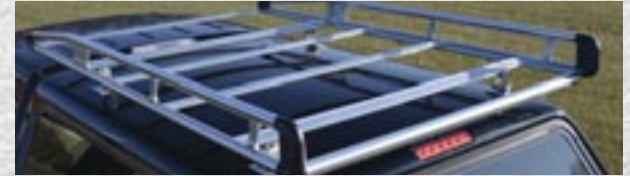

Prime Design™ AluRack™ (Option)

CENTURY® COMMERCIAL CAP FEATURES	DCU™-MT3	DCU	ULTRA CF	HIGH CCF
<b>SIDE DOOR</b>				
Fiberglass Painted Access Door			■	■
Radius Side Window 72" x 14" or Smaller (Dark tint glass)	■	■		
Radius Side Window (Dark tint glass)			■	■
Radius Side Window Slider			■	■
Radius Side Sliding Window	■	■		
50/50 Radius Side Sliding Window with Screen			■	■
Window Security Screen	■	■		
Pet Screens for Side Sliding Window			■	■
Full Side Wall Metal Skin Interior	■	■		
<b>TOOL BOX</b>				
Rubberized Non-Slip Mat for Tool Box Floor		■	■	■
Storage Solutions – Parts Bins and Shelf Bins		■	■	■
Tool Box 16"H x 12"D – 100RCC & 180CC (Requires Painted Side Access Door)			■	■
<b>TOOL BOX SHELF/DIVIDER</b>				
Includes Powder Coated (White) Metal Tool Box, Shelf, or Divider		■	■	■
Modular Tool Box	■			
<b>INTERIOR LIGHTING/POWER</b>				
Interior Wire Loomed and Secured	●	●	●	●
12V LED Tube Light – 20" and 42" with Prop Switch	■			
Interior LED Light Bar – 20" and 40"		■	●	●
12V Dome Light Gas Prop Switch (One switch per door)	■	■	■	
12V Three Outlet Power Block	■	■	■	■
<b>INTERIOR</b>				
Interior Headliner (Choice of black or grey)	■	■	●	●
Metal Skin Interior	■	■		
Interior Roof Rack	■	■		
Cargo Hooks			■	■

CENTURY® COMMERCIAL CAP FEATURES	DCU™-MT3	DCU	ULTRA CF	HIGH CCF
<b>EXTERIOR RACK</b>				
CENTURY DCU-MT3 TIG Welded Aluminum Ladder Rack – Six Position Mounting	■	■		
Boltplate Reinforcement Required for Thule®, CapRac, Kargo Master and Prime Design Systems	■	■		
Thule® – Tracker II Roof Rack System with Locks	■	■	■	■
Thule® – AeroBlade Roof Rack System with Locks			■	■
Thule® – Tracks Only			■	■
CapRac – Commercial Rack System (2-Bar set with 4 Load Stops)	■	■	■	■
Kargo Master Pro III Cap Mount Rack System	■	■	■	■
<b>PRIME DESIGN™ LADDER RACKS</b>				
AluRack™ Ladder Rack	■	■	■	■
ErgoRack® Single and Double Clamping Ladder Racks	■	■	■	■
ErgoRack® Single Clamping/Single Rotation Ladder Rack	■	■	■	■
ErgoRack® Dual Rotation Ladder Rack	■	■	■	■
<b>LADDER RACK ACCESSORIES*</b>				
AluRack™ Quick Clamp Option – DS or PS	■	■	■	■
ErgoRack® Quick Clamp Option	■	■	■	■
ErgoRack® "Go" Beacon Light Mounting Bracket	■	■	■	■
ErgoRack® "Strobe" Beacon Light Mounting Bracket	■	■	■	■
ErgoRack® Conduit Tube 5" x 10'	■	■	■	■
ErgoRack® "Strobe" Beacon Light Mounting Bracket for Conduit Tube	■	■	■	■
<b>TRUCK BED ACCESSORIES</b>				
Bedslide® Classic	■	■	■	■
Bedslide® Contractor	■	■	■	■
Bedslide® Heavy Duty	■	■	■	■
Decked Organizer	■	■	■	■
Bedrug Bedliner	■	■	■	■

[www.centurycaps.com](http://www.centurycaps.com)

\*Prime Design™ and Kargo Master racks not available for install on Wedge built Commercial Aluminum Units.  
DECKED is available for full-size short, full-size extra short and mid-size truck beds.

# COMMERCIAL CAPS - RUGGED & READY FOR THE JOB



*Prime Design™ ErgoRack™  
single rotation rack system*



*Operates safely from  
the rear of the vehicle*



*Easy ergonomic operation*



*Prime Design™  
ErgoRack™ single  
rotation rack system  
with step ladder option*

The ErgoRack™ by Prime Design™ is designed to minimize the physical stresses involved in loading and unloading heavy, bulky ladders. The single horizontal rotation positions ladders for easy access. ErgoRack™ reduces lower back and shoulder stress by eliminating the need to step on the bumper or tailgate to access a ladder. The lightweight design is lighter than steel ladder rack solutions for improved gas mileage and savings. Lockable security feature reduces theft at the job site and on the road.

## CENTURY®

**CAPS AND TONNEAUS**

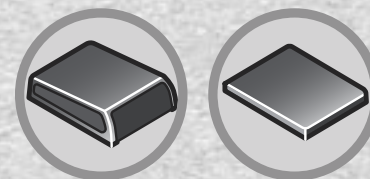

[www.centurycaps.com](http://www.centurycaps.com)

The information on this sheet may have been updated since printing and CENTURY truck caps and tonneaus may not be available for all import and domestic trucks. The equipment shown or described here may have regional plant manufacturing differences and may only be available as factory installed options at an additional cost. Check with your local CENTURY Dealer for complete product information. CENTURY reserves the right to make changes in prices, colors, materials, equipment, specifications, and models at any time without notice or prior obligation.

WARNING: This product contains chemicals known to the State of California to cause cancer and birth defects or other reproductive harm.  
©2019 CENTURY®. A Member Company of TAG, Truck Accessories Group. A Veteran Owned Company. 8/19 – Form #10795 • Part #80017



**Your CENTURY Dealer**